



**EBARA**

MCF001LA

# D'Series SUBMERSIBLE PUMP

Model **DS/DVS/DML/DL**

**50Hz**



**Sump Pump  
TYPE DS**

**Effluent Pump  
TYPE DVS**

**Sewage Pump  
TYPE DML**

**Sewage Pump  
TYPE DL**



# EBARA D'Series SUBMERSIBLE PUMP - *Quality that shows.....*

For Sump, Effluent,  
Waste water  
and Sewage.

A comprehensive range  
of Reliable, High quality  
Submersible pumps.

Of Robust Cast iron  
construction, with many  
design features.

## Model DS

### ■ FEATURES

- Efficient Semi-Open Impeller.
- Strainer prevents blockages.

### ■ APPLICATIONS

- Purification tank drainage
- Rain and spring water drainage
- Water supply

## Model DVS

### ■ FEATURES

- Semi-Vortex Impeller offers non-clog operation and allows pumping of foreign matter up to 60-70% of discharge size.
- Easy Maintenance.

### ■ APPLICATIONS

- Ideal for waste water applications containing soft or fibrous solids
- Industrial waste water drainage
- Septic effluent
- Miscellaneous drainage

## Model DML

### ■ FEATURES

- Non-Clog Single channel Impeller 3" passage.
- Range of Models up to 150mm discharge.
- Dry pit is available as optional.

### ■ APPLICATIONS

- Sewage
- Waste water

## Model DL

### ■ FEATURES

- Non-Clog Type Impellers prevents clogging by fibrous matter.
- Range of Models up to 300mm discharge size and 45kW available.

### ■ APPLICATIONS

- Sewage
- Waste water

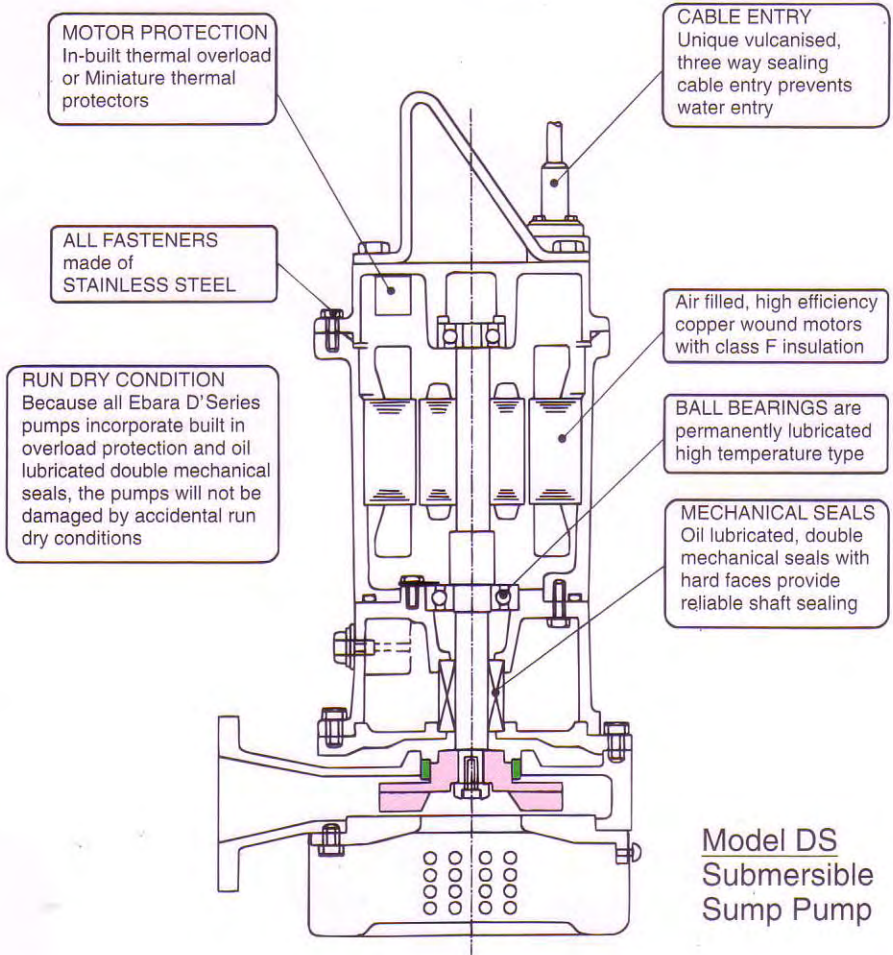

Model DS  
Submersible  
Sump Pump

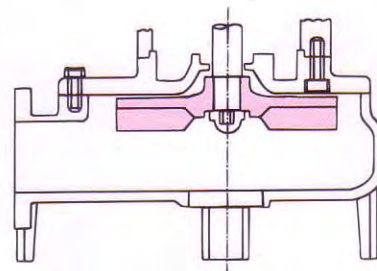

Model DVS  
Submersible  
Semi-Vortex  
Pump

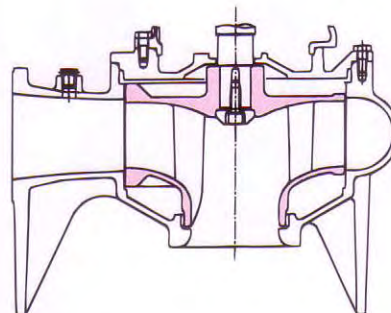

Model DML  
Submersible  
Sewage  
Pump

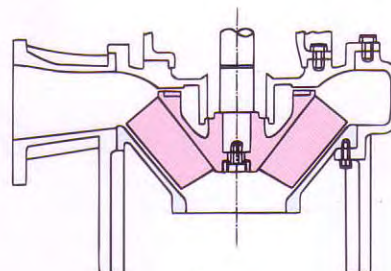

Model DL  
Submersible  
Sewage  
Pump



# Model DL

DL

DL 30/37/45 kW

## SPECIFICATIONS



		Standard	Optional
Scope	Discharge	65 - 300 mm	
	Motor Power	1.5 - 45 kW (3 phase)	
	Performance	Capacity : 0.07 - 12 m <sup>3</sup> /min Head : 3 - 52 m	
Liquid	Type	Sewage	
	Maximum Temperature	40° C (Manual and A Type) 32° C (J' Type)	
	Submergence	8 m (Max)	
Construction	Impeller	Non-clog type	
	Mechanical Seal	Oil lubricated, double mechanical seal (single spring 3.7 kW) (tandem spring 5.5 to 45kW)	
	Seal		
Materials	Casing	Cast Iron	
	Impeller	Cast Iron	S/S Upon request
	Suction Cover	Cast Iron	
	Shaft	403 Stainless Steel	
	Motor Frame	Cast Iron	
	Fasteners	304 Stainless Steel	
Mechanical Seal	Upper Faces	Carbon / Ceramic	
	Lower Faces	Silicon Carbide / Silicon Carbide	
Motor	Lubricating Oil	Turbine Oil VG32 (SAE 10W/20W)	
	Type	Air filled dry submersible, IP68, Class F insulation	
	Nominal speed	4 pole 1450 rpm	
	Applicable Voltages	380/400/415 volts 3 phase 50 Hz	
	Starting Protection	DOL (up to 7.5 kW) Star-Delta (11 to 45 kW)	
	In built overload protection	(up to 7.5 kW)	Leakage detector upon request
	Miniature thermal protector	(11 to 45 kW)	
	Bearings	Pre lubricated sealed ball bearings	
	Length	10m	
	Accessories	Flange Discharge elbow	
Others		Quick Discharge Connector (QDC)	

## MODEL CODE

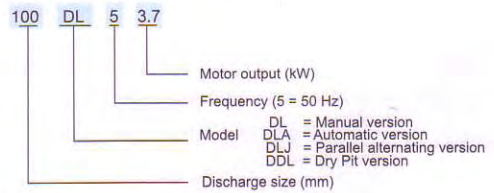

## PERFORMANCE CHART

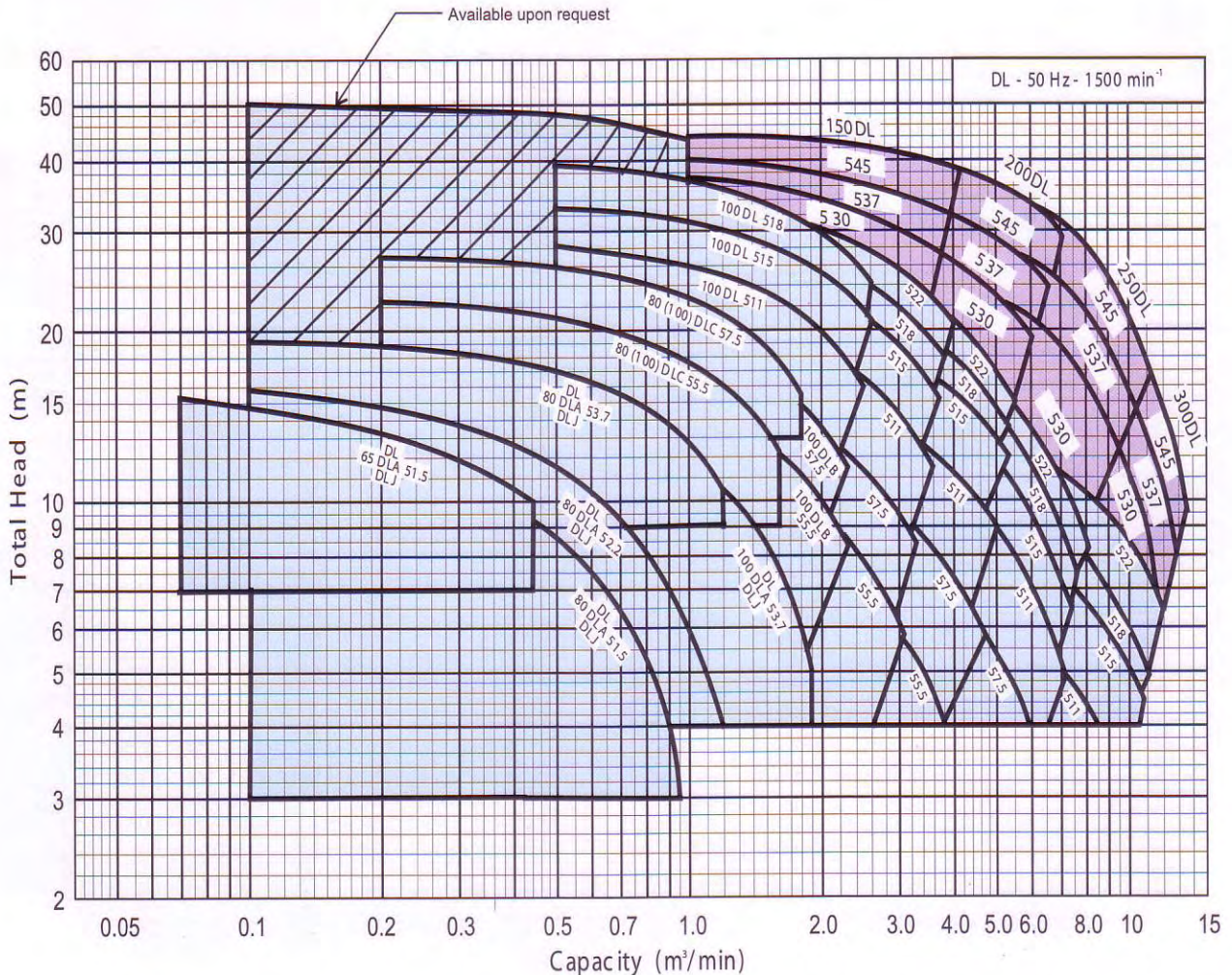



# Dimensions - DL (MANUAL WET PIT MODEL)

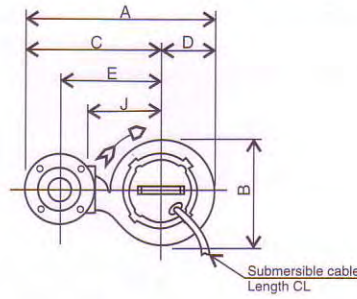
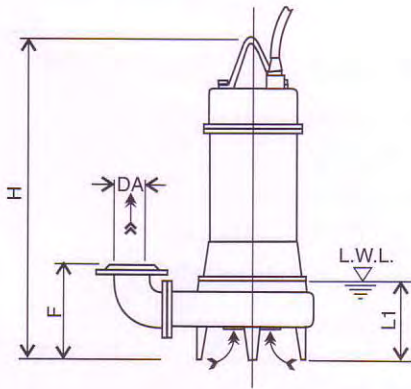

Discharge Flange Dimensions (JIS 10kgf/cm<sup>2</sup>)

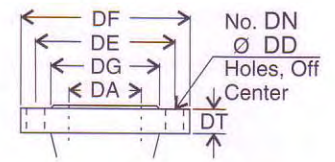

DA	DE	DF	DG	DT	DN	DD
65	150	175	116	18	4	15
80	150	185	126	18	4	15
100	175	210	151	20	8	15
150	240	280	212	22	8	19
200	290	330	262	26	12	23
250	355	400	324	30	12	25
300	400	445	368	32	16	25

- Note:
- 1/. L.W.L. (Low Water Level) Is limited to 10 minutes operation at low water level.
  - 2/. Is limited to 30 minutes operation with water level below top of motor.

Size DA	Model	Output kW	A	B	C	D	E	F	H	J	L1	CL	Weight
65	65 DL 51.5	1.5	497	291	353	144	265	200	576	200	140	10 m	52 kg
80	80 DL 51.5	1.5	524	292	378	146	285	220	597	210	165	10 m	55 kg
	80 DL 52.2	2.2	542	308	388	154	295	220	654	220	165	10 m	67 kg
	80 DL 53.7	3.7	567	328	403	164	310	220	687	235	165	10 m	75 kg
	80 DLC 55.5	5.5	618	379	428	190	335	307	753	260	205	10 m	134 kg
	80 DLC 57.5	7.5	648	399	448	200	355	305	751	280	205	10 m	148 kg
100	100 DL 53.7	3.7	614	335	445	169	340	250	706	235	185	10 m	79 kg
	100 DLB 55.5	5.5	646	369	460	186	355	323	768	250	205	10 m	123 kg
	100 DLC 55.5	5.5	660	379	470	190	365	322	753	260	205	10 m	134 kg
	100 DLB 57.5	7.5	673	385	480	193	375	323	760	270	205	10 m	141 kg
	100 DLC 57.5	7.5	690	399	490	200	385	320	751	280	205	10 m	148 kg
	100 DL 511	11	701	402	500	201	395	323	859	290	205	10 m	180 kg
	100 DL 515	15	741	441	520	221	415	330	954	310	205	10m	230 kg
	100 DL 518	18.5	741	441	520	221	415	330	958	310	205	10 m	285 kg
150	150 DL 55.5	5.5	750	398	550	200	410	381	799	280	245	10 m	146 kg
	150 DL 57.5	7.5	780	418	570	210	430	377	784	300	245	10 m	158 kg
	150 DL 511	11	810	438	590	220	450	377	883	320	245	10 m	199 kg
	150 DL 515	15	810	438	590	220	450	377	972	320	245	10 m	237 kg
	150 DL 518	18.5	848	476	610	238	470	381	979	340	245	10 m	300 kg
	150 DL 522	22	848	476	610	238	470	381	979	340	245	10 m	325 kg
	150 DL 530	30	912	520	650	262	510	468	1284	360	1080	10 m	350 kg
	150 DL 537	37	912	520	650	262	510	468	1404	360	1135	10 m	350 kg
	150 DL 545	45	912	520	650	262	510	468	1404	360	1135	10 m	350 kg
200	200 DL 55.5	5.5	832	430	615	217	450	414	826	300	285	10 m	160 kg
	200 DL 57.5	7.5	863	453	635	228	470	410	809	320	285	10 m	176 kg
	200 DL 511	11	863	453	635	228	470	410	908	320	285	10 m	212 kg
	200 DL 515	15	896	479	655	241	490	411	995	340	285	10 m	260 kg
	200 DL 518	18.5	932	512	675	257	510	415	1001	360	285	10 m	305 kg
	200 DL 522	22	932	512	675	257	510	415	1001	360	285	10 m	330 kg
	200 DL 530	30	937	520	675	262	510	483	1284	360	1080	10 m	350 kg
	200 DL 537	37	937	520	675	262	510	483	1404	360	1135	10m	370 kg
250	250 DL 545	45	937	520	675	262	510	483	1404	360	1135	10 m	370 kg
	250 DL 57.5	7.5	969	525	700	269	500	622	904	370	400	10 m	260 kg
	250 DL 511	11	993	541	720	273	520	634	1000	390	400	10 m	320 kg
	250 DL 515	15	1007	549	730	277	530	646	1086	400	400	10 m	380 kg
	250 DL 518	18.5	1007	549	730	277	530	646	1089	400	400	10 m	420 kg
	250 DL 522	22	1007	549	730	277	530	646	1089	400	400	10 m	440 kg
	250 DL 530	30	1125	660	790	335	590	706	1336	460	1132	10 m	458 kg
300	250 DL 537	37	1125	660	790	335	590	706	1475	460	1206	10 m	522 kg
	250 DL 545	45	1125	660	790	335	590	706	1475	460	1206	10 m	540 kg
	300 DL 511	11	1100	588	798	302	575	671	1050	420	450	10 m	365 kg
	300 DL 515	15	1100	588	798	302	575	671	1131	420	450	10 m	395 kg
	300 DL 518	18.5	1135	618	818	317	595	668	1131	440	450	10 m	440 kg
	300 DL 522	22	1135	618	818	317	595	668	1131	440	450	10 m	465 kg
300	300 DL 530	30	1172	660	838	335	615	726	1336	460	1132	10 m	458 kg
	300 DL 537	37	1172	660	838	335	615	726	1475	460	1206	10 m	522 kg
	300 DL 545	45	1172	660	838	335	615	726	1475	460	1206	10 m	540 kg

Units: mm unless otherwise specified



## AUTOMATIC OPERATION (A' & J' TYPE)

All models up to 3.7kW are available as automatic (A' type) or parallel alternating (J' type) pumps with inbuilt control devices and float switches. There is no need for an external control panel, and operation can begin as soon as the pumps are installed and connected to a power source.

### SINGLE PUMP INSTALLATION (A' TYPE)

A single automatic (A' type) pump is installed in the sump. The pump automatically starts when the water level in the sump reaches the "start level", and stops when the pump has lowered the water level to the "stop level".

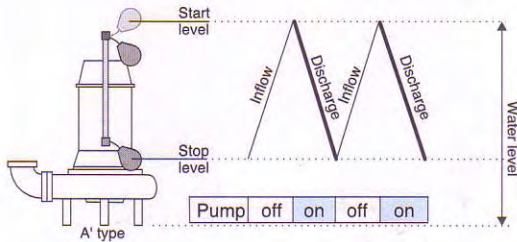

### DUPLEX PUMP INSTALLATION (A' & J' TYPE)

Two pumps, one A' type and one J' type are installed in the sump. In normal operating conditions, operation alternates between the two pumps. In times of extraordinary inflow (inflow is greater than the capacity of a single pump), then the two pumps will operate together in parallel operation.

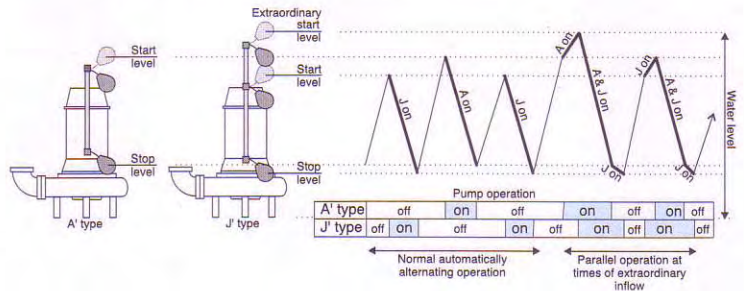

## FLOAT SWITCH

FLOAT SWITCH	
Model	EF-4
Temperature	0~50°C
Function of contact	Up = ON Down = OFF
Voltage	AC 24V DC 24 V
Max Current	AC 0.5A DC 0.5A
Contact Capacity	AC 12VA DC 12VA
Lead Wire	2x0.2mm <sup>2</sup> x6m

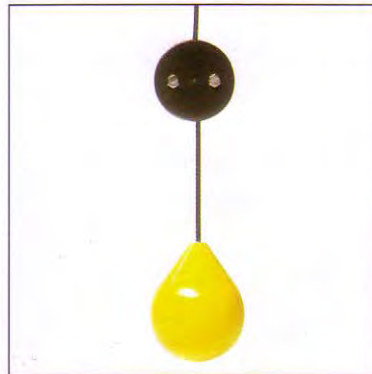

## QUICK DISCHARGE CONNECTION (QDC)

An optional quick discharge connector is available to suit all Ebara D'Series submersible pumps, allowing easy removal and replacement of the pumps for maintenance purposes without having to enter the sump.

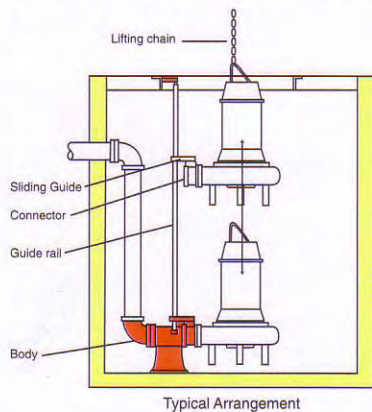

Typical Arrangement

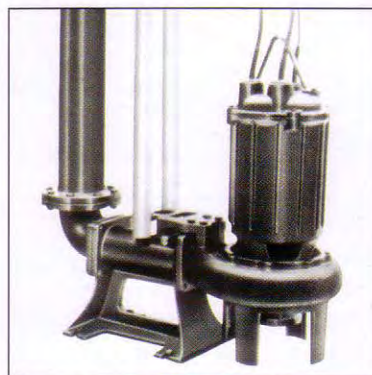

EBARA Pump with QDC - Typical Arrangement

Note: All specifications subject to change without prior notice.



**EBARA** CORPORATION

Standard Products Business Office

Phone : 81-3-5461-6101

Fax : 81-3-5460-4930

Website : <http://www.ebara.co.jp>